

INSTALLATION INSTRUCTIONS
SOLID HARDWOOD



Table of Contents

Page Three

- Owner/Installer Responsibilities
- Grading Standards/Rules
- Storage & Handling

Page Four

- Pre-installation inspection
- Acclimation & Climate Control
- Acclimation & Climate Control (temp & humidity)
- Other wood industry standards

Page Five

- The Role of HVAC
- Adverse Environment Warning System - Fidbox
- Pre-Installation Inspection

Page Six

- Install Flooring Last – After other trades complete
- Warning Paper/Cardboard Effect on Nu Oil Finish
- Exterior Checks
- Basement Moisture & Humidity Control

Page Seven

- Crawl Space Ventilation
- Sealed Crawl Space
- Moisture Testing Concrete

Page Eight

- NWFA Concrete Moisture Testing Standards
- Adhesive Clean Up & Effects on Surface Finishes
- Adhesive Recommendation (MS Polymers)

Page Nine

- Subfloor Preparation Concrete
- Prop 65
- Asbestos Caution
- Existing Floor Coverings on Concrete

Page Ten

- Subfloor Moisture Testing Wood
- Subfloor Preparation WOOD
- Truss/Joist Spacing
- Joist Cross-Bracing

Page Eleven

- Direction of installation in relation to direction of joists
- Double Layer Subfloors (when to sheet the top of the subfloor)

Page Twelve

- Existing Wood Floors
- Radiant Heat – Hydronic

Page Thirteen

- Below Grade Installation

Page Fourteen

- Below Grade Installation continued

Page Fifteen

- Glue Down Installation

Page Sixteen

- Nail Down Installation

Page Seventeen

- Approved Nail / Cleat Systems
- Noisy Floors

Page Eighteen

- Nail Down Installation Continued
- Glue Assist Nail Down

Page Nineteen

- Floating Installation

Page Twenty

- Clean Up

Attention

Before starting installation, read all instructions thoroughly. Should any questions arise, please contact your local Hallmark Floors dealer. Instructions available at www.hallmarkfloors.com. Instructions also available via cell phone, using the QR Code on the pre-installation check list found in the box. All installation instructions must be followed for warranties to be considered valid. Pre-inspect the job site prior to delivery of the floor to ensure the structure is suitable for hardwood flooring installation using the following guidelines:

Owner/Installer Responsibility

1. Inspect the hardwood flooring in well lighted conditions to ensure proper identification of any potential problems. Carefully inspect the flooring for grade, (see Hallmark Floors grading standards at www.hallmarkfloors.com) for color, finish, milling and overall quality. If the flooring is not acceptable, contact the original Hallmark retailer and/or distributor to arrange shipment of replacement material. Defective product will be replaced. Material that is subjectively viewed as unacceptable but falls within Hallmark Floors' grading norms will not be replaced.

IF THE FLOORING AS SUPPLIED WILL NOT SATISFY THE CUSTOMER IN FULL, DO NOT PROCEED TO INSTALL. The decision not to proceed must be made within the first 10% or 100 square feet of flooring boxes opened, whichever is less. Open boxes exceeding this amount will not be eligible for return. This does not apply to material left over from a completed job.

2. Prior to installation of any flooring, the installer must ensure the job site and sub-floor conditions meet the requirements specified in these instructions.

3. Hardwood flooring installation should be one of the last items completed on the construction project. Limit foot traffic on the finished wood floor.

Grading Standards

General Rules:

Flooring shall be tongue and grooved and end matched (unless otherwise indicated). Flooring shall not be considered of standard grade unless properly dried. The drying standard for Hallmark product shall be 8 to 10% moisture content by volume with a plus or minus factor of 2% for storage conditions in various climate zones.

Grading Rules:

Hallmark Floors, like many flooring and lumber mills, uses a proprietary grade for manufacturing our floors. Proprietary grades are generally referred to as Mill Run. Instead of separating the lumber into traditional NOFMA/NWFA grades, the flooring is a mix of grades. This enables Hallmark to produce wider and longer boards. Hallmark grading rules allow for filled knots, mineral streak, open checks, tight checks, and filled checks. Bird peck, pin worm hole, and flag worm hole are acceptable (any insects are killed in drying process). Plank faces may also contain unlimited amounts of heart wood (dark portion of log) and/or sap wood (light portion of log).

NOTE: Organic Solid 3 ¼" & 4" is textured prior to drying to achieve the true look of reclaimed wood. As such, the edges will have height variations, just like material reclaimed from an old building. Over and under, or height variation from plank to plank, is an inherent part of the rough sawn nature of reclaimed, which Hallmark Floors emulates in our manufacturing process. This is not considered to be a defect.

Environmental Issues

Damage caused by inappropriate handling, environment, installation, or maintenance issues will not be considered in relationship to grade. **NOTE: DO NOT REMOVE PRODUCT FROM BOXES FOR ACCLIMATION UNTIL COLOR AND FIT ARE DETERMINED TO BE ACCEPTABLE BY THE HOMEOWNER.** Once material is removed from boxes it is considered to be accepted by the installer and consumer.

Storage and Handling

Handle and unload wood flooring with care. Store in a dry place; Make sure to provide at least a four-inch space (using dry 4" x 4" stickers or a dry pallet

that provides enough clearance under boxes for proper air movement. Prior to delivery of flooring, outside doors and windows must be in place.

All concrete, masonry, plastering, and other “wet” work must be complete and thoroughly dry prior to flooring installation. Roofing and the exterior shell of the structure must be finished and weather tight with doors and windows installed.

The wall coverings should be in place and all painting completed—except for the final coat on the base molding. Room temperature and humidity should be consistent with year round conditions for at least one week prior to installation. When possible, install base molding after floor installation is complete.

HVAC MUST BE RUNNING WITH A ROOM TEMPERATURE OF BETWEEN 60°F TO 80°F AND RELATIVE HUMIDITY OF BETWEEN 30 AND 55%.

NOTE: See Hallmark Healthy Home for greater detail on how proper humidity ranges can be maintained.

Pre-Installation - Site Inspection

VISUAL INSPECTION

The first inspection is visual and basic. Is there water in the building? Are the doors and windows installed and the building weather tight?

CLIMATE CONTROL

If heating and/or air conditioning with proper humidity controls are in operating condition, they need to be turned on. If it is not possible for the permanent system to operate, a temporary system that provides proper temperature and humidity conditions must be in place and remain in place until permanent climate control is operational. NOTE: Intended for indoor use only.

Exterior Checks

1. Proper drainage away from the structure is absolutely critical to ensure weather-tight conditions and crucial to proper hardwood flooring performance. If structure is near a hill,

the lot should be graded with a swale to move moisture off the lot and prevent it from coming in contact with the foundation.

2. Is exterior soil elevation 6” below edge of flashing?

3. Is exterior hardscape (concrete, wood decks, pavers) elevation at least 2 ½” lower than edge of flashing and door thresholds?

4. Does exterior slope away from foundation at a rate of 6” drop in 10’ for soft landscaped areas and 3” drop in 10’ for hard-paved areas?

5. Rain gutters must be in place to carry moisture away from the house. French drains are recommended, and basement walls should be properly sealed.

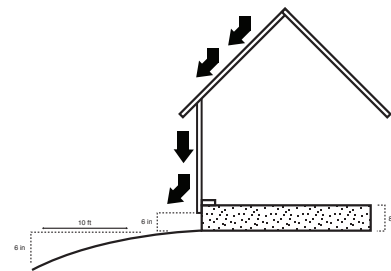

Basement Moisture & Humidity Control

Basements should be completely weather tight and have proper drainage away from the foundation walls in place to ensure that the basement remains dry.

1. Basement should be free of all moisture and be weather tight.
2. Relative humidity of basements should not be more than 10% higher than the upper floors.
3. Humidity control of the basement is vital to help control mold and prevent damage to the structure and hardwood flooring.
4. Basement walls should be inspected for cracks and excessive moisture content.
5. Drains must be placed at basement windows.
6. Direct sprinklers and irrigation systems away from the foundation. Sprinklers spraying the foundation edge can lead to moisture intrusion into structure. Drip irrigation systems for plant beds is recommended.

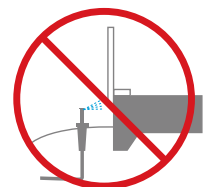

Crawl Space Ventilation

Crawl space earth (or thin concrete slab) should be covered 100% by a vapor retarder of black polyethylene (minimum 6 mil) or any recommended puncture resistant membrane, such as Class C meeting ASTM D1745. Check local codes or any additional requirements.

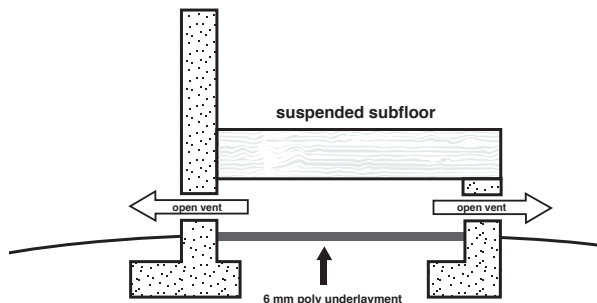

Size of available vents should equal to 1.5% of the square footage within the crawl space. Relative humidity should be consistent with interior of home.

Moisture content of sub floor should not vary more than a 2% MC from the top of the sub floor to the bottom.

It may be necessary to install temperature/humidity activated exhaust fans to create more air movement in the crawl space. Uncontrolled humidity and moisture in crawl space will lead to mold and damage to the structure, as well as the hardwood floor. In these events, a contractor specializing in dehumidifying systems will need to be contracted to keep crawlspace humidity within proper norms. This is more likely in high humidity areas.

It may be necessary to install temperature/humidity activated exhaust fans to create more air movement in the crawl space.

Uncontrolled humidity and moisture in crawl space will lead to mold and damage to the structure, as well as the hardwood floor. In these events, a contractor specializing in dehumidifying systems will need to be contracted to keep crawlspace humidity within proper norms. This is more likely to be found in areas that have high humidity or areas that experience very cold temperatures.



NOTE: Completely sealed crawlspaces (no exterior cross-ventilation) require a dehumidification system as part of the sealed crawlspace design.

Subfloor Moisture Testing CONCRETE

Since wood flooring is not compatible with wet conditions, Hallmark Floors does not warrant against moisture related issues or related damage under warranty. (See Hallmark Floors Maintenance & Warranty Guides). This is an industry standard, and manufacturers do not offer moisture warranties. Adhesive manufacturer's offer moisture warranties for moisture abatement systems that will be conditional. Follow their directions closely to ensure compliance and full warranty coverage. Proper spread rate and coverage are very important. warranties. However, moisture warranties are offered by various adhesive manufactures.

NOTE: Due to the porous nature of concrete, vapor emissions are subject to change over the lifetime of the installed floor. Slab moisture emissions are a common cause of damage to hardwood floors. Due to the potential for concrete moisture emissions to increase/decrease over time, and the absence of moisture warranties for wood flooring, choosing an adhesive system that includes moisture abatement properties is prudent.

NOTE: Some adhesive manufacturers offer adhesive/moisture abatement systems that do not require pre-installation testing of the slab to maintain a moisture warranty. Check with adhesive manufacturer to confirm which products they offer, that allow installation without pre-checking/testing the slab.

ADDITIONAL NOTE: Hallmark Floors makes no guarantees regarding the performance of any adhesive/vapor abatement system.

The installer is fully responsible for proper installation, and the moisture warranties are fully the responsibility of the adhesive moisture abatement systems manufacturer. **Use proper trowel size and replace trowels at the recommended square footage intervals the adhesive manufacturer requires to ensure proper application thickness.**

NWFA Moisture Testing Standards

The NWFA (Industry standard) uses the following test methods to determine optimal conditions for installation and performance of a hardwood floor. Follow adhesive manufacturer's specifications for testing of concrete subfloor.

Some adhesive manufacturers offer systems that create a vapor barrier to protect the wood flooring from moisture emissions coming up through the slab. Many adhesive manufacturers require the tests listed below to be performed prior to installation of the floor. Carefully read and follow the adhesive manufacturer's instructions.

CALCIUM CHLORIDE: ASTM F1869

Under ideal conditions, the slab should not be emitting more than 3 lbs. per 1,000 square feet per 24 hour period. Carefully follow the instructions in the test kit to ensure that you get accurate results.

NOTE: The slab emissions can vary based on soil humidity and room temperature. Consult adhesive manufacturer's directions for the moisture abatement system they recommend.

HUMIDITY PROBE & DIGITAL METER: ASTM F2170

Widely used in Europe, this test determines the amount of humidity in the slab. This is an effective way to determine a slab's potential for emitting moisture.

Follow all meter manufacturer's guidelines for performing testing. Under ideal conditions, the slab readings should be 75% RH.

Acclimation & Climate Control

Wood flooring is a hygroscopic material subject to dimensional change as a result of variations in moisture, temperature, and humidity within the surrounding environment. Wood flooring simply needs to reach a moisture content level in equilibrium with the surrounding environment (EMC) IN WHICH IT WILL BE INSTALLED, AT OR NEAR NORMAL LIVING CONDITIONS

EQUILIBRIUM MOISTURE CONTENT - EMC

The moisture content of Wood – and corresponding width of the plank, is a function of both relative humidity and temperature in the surrounding air. When Wood is neither gaining nor losing moisture, an equilibrium / equalized moisture content (EMC) has been reached.

The width of a board expands or contracts in relationship to EMC. Potential change in normal range of between 30% and 55% is 3.5% EMC. This can translate to a change (shown in charts below) of 3/64" each plank (+/-). See charts page 7

The less change in relative humidity the less movement in the planks. In an environment that goes to both ends of the range, a dimensional change of 3/64" in the width of a 5" plank is possible. EXAMPLE: Material acclimated in a 30% environment that changes to 55% will expand 3/64" placing the floor under stress. Material acclimated at 55% and changes to a 30% will experience gapping between the planks (neither scenario is considered a manufacturing defect). See dimensional change chart page 7.

Hallmark Floors manufactures material to mimic what would be found in the middle of a 30-55% relative humidity environment (roughly 40% RH). Consequently, it is pre-acclimated to the green zone conditions found in the chart next page.

1. Determine Normal Climate Conditions:

Normal interior climate conditions vary among different geographical regions, and jobsites vary for numerous reasons as well. Determination of what environmental conditions should exist during acclimation period is the responsibility of the installation professional.

2. Climate Conditions at Time of Acclimation:

Acclimation should occur in normal living conditions at the middle of the normal relative humidity swing for the area. In areas where relative humidity falls below 35%, humidity control must be added to HVAC / Climate Control Systems, to prevent the floor from becoming too dry.

3. General Timelines for Acclimation:

The amount of time required greatly depends on proper control of the indoor environment (temperature and humidity). For regions where the relative humidity is at the lower or higher range more time will be required. The real equation is how much acclimation vs. how long. However, Hallmark Floors recommends that the flooring material should be acclimated for a minimum of 5 days in a properly controlled environment (average acclimation time 5 to 7 days).

Humidity ranges and EMC vary geographically. Understanding the average conditions for your region is critical to the acclimation process. If an acclimated EMC is too low, the installed floor will over expand as the relative humidity goes up. If the acclimated EMC is too high the floor boards will gap excessively as the relative humidity drops later on. (See page 8)

Reminder: Time is only $\frac{1}{2}$ the equation. Additional time may be required for acclimation where conditions are not well controlled.

4. Cross Stack Planks:

For optimum acclimation and stability, Hallmark Floors recommends the cross-stacking of planks in the structure where it is being installed. Stacking on a 4" high pallet or 4" x 4" stickers will allow air circulation full access to all the planks, Stack and gap the planks evenly for optimum air flow and uniform acclimation of the planks.

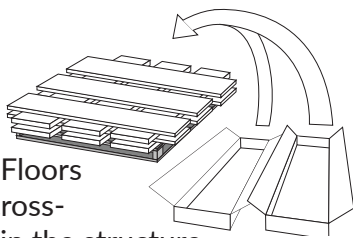

REMINDER: DO NOT REMOVE PRODUCT FROM BOXES FOR ACCLIMATION UNTIL COLOR AND QUALITY ARE DETERMINED TO BE ACCEPTABLE BY THE HOMEOWNER.

5. Air Flow:

The use of oscillating fans can aid in air movement and assist in moving the air around the material. Point fans away from stack to pull the air through the stack and disperse air throughout the room. Material left in boxes will take much longer to acclimate, due to restricted air flow.

6. Ideal Room Location for Acclimation:

Place cross stacked material as close to the center of the total installation area as possible. Do not store or acclimate material against exterior wall. Avoid direct sunlight, and keep away from HVAC vents, **DO NOT ACCLIMATE** in structure without climate and humidity controlled conditions. Garages, covered porches/patios, and non climate controlled basements are not suitable places for acclimation of material.

NOTE: A certain amount of humidity swing is considered to be normal and some tightness and gapping can occur in normal use.

To maintain proper relative humidity levels, above 30% and below 55% RH, use of the following equipment is recommended. Failure to maintain humidity range can damage the floor.

The National Wood Flooring Association and every major manufacturer of wood flooring sold in the United States mentions humidity and temperature control in their installation instructions, and warranties.

Other wood industry standards:

Musical instruments, furniture, and cabinet manufacturers also recognize the need for temperature and humidity control.

WIKIPEDIA - Piano Maintenance: Most technicians recommend an indoor relative humidity within the range of **30% to 50%**, kept constant.

PIANO TECHNICIANS GUILD: Seasonal and even daily changes in **humidity** cause wood parts to swell and shrink, affecting tuning stability and touch. Extreme swings in **humidity** can eventually cause wood to crack and glue joints to fail

WIKIPEDIA - Wood Furniture: **Temperature and relative humidity.** To prevent cracks and veneer cleavage, avoid placing furniture near radiators, heat vents or other areas

where temperature and relative humidity (RH) fluctuate widely. A stable relative humidity is particularly important to furniture since rapid changes cause different parts of

DIMENSIONAL CHANGE CHART – Coefficient of change in EMC to width of 5” Plank			
Moisture Content Change	Possible Width Change	Moisture Content Change	Possible Width Change
1%	1/64”	5%	1/16” Full
2%	1/32”	6%	5/64”
3%	3/64”	7%	3/32”
4%	1/16” Scant	8%	7/64”

Indoor Relative Humidity RH																					
Temperature Fahrenheit	5	10	15	20	25	30	35	40	45	50	55	60	65	70	75	80	85	90	95	98	
	30	1.4	2.6	3.7	4.8	5.5	6.3	7.1	7.8	8.7	9.5	10.4	11.3	12.4	13.5	14.9	16.5	18.5	21	24.3	26.9
	40	1.4	2.6	3.7	4.8	5.5	6.3	7.1	7.8	8.7	9.5	10.4	11.3	12.4	13.5	14.9	16.5	18.5	21	24.3	26.9
	50	1.4	2.6	3.6	4.6	5.5	6.3	7.1	7.9	8.7	9.5	10.3	11.2	12.3	13.4	14.8	16.4	18.4	20.9	24.3	26.9
	60	1.3	2.5	3.6	4.6	5.4	6.2	7	7.8	8.6	9.4	10.2	11.1	12.1	13.3	14.6	16.2	18.2	20.7	24.1	26.6
	70	1.3	2.5	3.5	4.5	5.4	6.2	6.9	7.7	8.5	9.2	10.1	11	12	13.1	14.4	16	17.9	20.5	23.9	26.6
	80	1.3	2.4	3.5	4.4	5.3	6.1	6.8	7.6	8.3	9.1	9.9	10.8	11.7	12.9	14.2	15.7	17.7	20.2	23.6	26.3
	90	1.2	2.3	3.4	4.3	5.1	5.9	6.7	7.4	8.1	8.9	9.7	10.5	11.8	12.6	13.9	15.4	17.3	19.8	23.3	26
	100	1.2	2.3	3.3	4.2	5	5.8	6.5	7.2	7.9	8.7	9.5	10.3	11.2	12.3	13.6	15.1	17	19.5	22.9	25.6

Relative Humidity, Humidity, & EMC Table
From the US Dept. of Agriculture Wood Handbook, Wood as an Engineering Material

the object to expand and contract at different rates and to different degrees. If the relative humidity is over 60% fungi such as molds and mildews, will become rampant on wooden furniture.
The recommended range for wooden furniture is 45%-55% RH. Impacts of change in RH on wooden furniture:

Wood Reactions to Environmental Change

Low RH

Wood shrinks and splits. Joints become loose and the elements no longer fit together tightly. Veneers and inlays suffer- If the underlying carcass wood shrinks, cracks will appear in the veneer and inlays become loose. When the glues holding them down fail, veneers lift. Causes polishes to shrink, craze and flake.

High RH

Swelling can cause moving parts such as cabinet doors or drawers to jam. If glue fails, veneer peels away. Corrosion affects nails holding things in place, metal inlay and fillings. Insects and rot may flourish as the content of the wood rises fast and constant cycling of RH fluctuations causes the most damage for all of the above to create rapid structural weakening.

Relative Humidity & Air Quality

Control of humidity levels in the atmosphere is vital to optimum health. If humidity levels are not maintained within the 30 to 55% humidity range, it can have adverse effects on human health.

The Center for Disease Control and Prevention recommends humidity be set between 35%-50%. An ARIC report notes that areas with a relative humidity of lower than 50% had fewer rates of asthma. Low humidity can lead to discomfort such as dry, itchy skin or throat irritation. Low atmospheric humidity pulls moisture out of humans and their pets. Lower moisture in the respiratory system can lead to upper respiratory distress. Low humidity and high humidity environments present multiple health

ASHRAE – American Society of Heating Refrigeration and Air Conditioning

The Role of HVAC

Low Indoor Humidity: Is generally experienced in areas that are very cold in the winter or very hot in the summer. In cold areas the indoor air is heated and the moisture goes up the vent pipe, depriving wood objects of the humidity required for a healthy moisture content.

Whole house humidification systems are the most efficient way to prevent dry wood damage to floors, cabinets, musical instruments, doors, molding & millwork. The addition of moisture/humidity will make the heating system more efficient as well.

High Indoor

Humidity: Is generally seen in the summer time in many areas of the country where outdoor relative humidity gets very high. Air conditioning as a whole will remove a great deal of humidity from indoor air. However, this works the air conditioning unit very hard and in most areas air conditioning levels are set in the 60's to remove enough moisture for the room to be comfortable. Dehumidifiers can be added to the HVAC system to take a lot of the strain off of an air conditioning unit. Dehumidifiers are much less expensive than air conditioners, and dehumidifiers can make the air conditioner last longer and be far more energy efficient.



Homeowners need to be aware of the vital role that relative humidity plays in wood performance. Not just flooring but anything made of wood found in a home, including the structure itself.

Low Moisture / High Moisture Warning

Adverse Conditions Warning: It is possible at the time of install to place a device/devices in the floor that will warn the consumer when the floor is getting too dry or too damp. It logs the data from the floor and the indoor environment continuously. It is installed within the floor at time of installation. The use of Fidbox is highly recommended in areas that experience humidity below 30%.

Fidbox, is a data logging device. The device is Blue Tooth connected and the consumer can track the condition of the floor. It is like a check engine light that can warn of pending trouble. Then adjustments can easily be made to the



climate control to prevent damage to the floor.

Since proper climate and humidity control is required, this device while optional, can make the difference between a successful installation and a site induced/non manufacturing related failure of the wood floor.

See Fid Box application instructions at www.fidbox.net/ for full instructions on installation and use.

INSTALL FLOORING LAST

Hardwood floor should be the last trade in the house (before base boards are installed). All concrete, masonry, plastering/drywall, texturing, and painting/primer coats should be completed beforehand. Covering the floor while wet trades are in the house can lead to moisture condensation on the protective paper. Moisture can pull into the paper or be trapped under the surface of materials used to cover the floor. Paper coverings also allow dents and scratching to occur. Coverings held in place for more than 24 hours by blue tape can damage the floor. The adhesive in tapes contain Phthalates /plasticizers that have the ability to penetrate floor finishes and bond with the finish at the molecular level presenting a risk of pulling/damaging the finish when the tape is removed. Hallmark recommends that built in cabinets and built in furniture be installed before installation of the floor. This prevents damage to the flooring, and makes any potential flooring repairs that may be required at a later date simpler to perform.

WARNING COVERING NU OIL® FINISH WITH PAPER OR CARDBOARD

Paper and cardboard can be abrasive. Possible debris, from the jobsite, in between the covering and the floor can add to the abrasive property's in certain coverings, and open up the oil coating possibly making it vulnerable to surface stains. Floors are most often installed too early, without climate control, and when other wet trades are present in home. Paper and cardboard often absorb moisture possibly further damaging the finish. An additional coating can be done after all other trades are out of the house to revive the finish.

NOTE: Additionally, If the floor is left uncovered while other trades perform their work, the floor finish could be compromised and an additional coat of Restoration Oil will revive the finish.

CAUTION: Post Tension Slabs require special care to avoid cutting cables in slab. Cutting post tension cables can cause serious structural damage and potential fatalities.

New concrete slabs require a minimum of 60 days drying time before covering them with a wood floor. The slab must be fully cured. Slab must be comprised of Portland-based mix with 2,500 PSI of compressive strength.

Adhesive Clean Up & Effects on Surface Finishes

Moisture Curing Polyurethane Adhesives: are problematic for Oil Finished Floors. Moisture Curing Urethanes require heavy solvent cleaners to remove adhesive residue from the surface of the floor. These solvents strip the oil and make the floor vulnerable to stains..

A coat of Restoration Oil must be added to any Nu Oil® finished floor that has come in contact with Moisture Curing Polyurethane Adhesives

Additionally, Moisture Curing Polyurethane Adhesives, can also cause problems for UV cured polyurethane finishes. When allowed to dry the adhesive cures to the top of the floor finish leaving smudges on the floor. When attempting to remove urethane glues that have cured to the surface, removal attempts leave shiny or dull spots in the finish. This then requires a pad and recoat to repair the damage.

MS Polymer Adhesives

Many MS Polymer adhesives provide moisture abatement capabilities. To avoid damage to finish from urethane adhesives, Hallmark Floors, recommends MS Polymer adhesive systems with vapor abatement capabilities, and with moisture abatement warranties.

Sub floor Preparation CONCRETE

For glue down application over gypsum or lightweight concrete, the same 2,500 PSI rating is required. (See floating installation section for installation over lightweight substrates).

Note: Some adhesive systems have primers and adhesives that are suitable for use over gypcrete or lightweight concrete, and may have different PSI compressive strength requirements. Adhesive manufacturer is responsible for performance of their systems over gypcrete or lightweight concrete.

Remove all paint, oil, existing adhesives, wax, grease, dirt, sealers, and curing compounds. Do not use solvent-based strippers under any circumstances, as residual solvents can prevent the satisfactory bonding of the vapor barrier and adhesive systems. It is important to ensure a long-lasting bond between the adhesive, the concrete, and the boards. FOLLOW ALL ADHESIVE APPLICATION INSTRUCTIONS.

Industry standard practice is to use a sanding system with 20 grit # 3½ open face paper to remove loose, flaky concrete. For heavy surface contamination, it may be necessary to bead blast the concrete surface.

NOTE: Adhesive manufacturers generally recommend prep fillers and patches to repair concrete substrates that are compatible with the adhesive system to be used. Make sure you use the prep products that are recommended by the adhesive manufacturer.

Sub floor tolerance for a flat surface is 3/16" within a 10' radius and 1/8" in a 6' radius. These are industry standards established by NWFA. Use a straight edge to determine if sub-floor requires grinding or filling.

NOTE: A quarter is approximately 1/16" thick and can be used as a thickness gauge. Grind high spots and fill low spots with adhesive manufacturer's recommended filler.

REMINDER: Use the filler recommended by the adhesive manufacturer.

California Prop 65 Warning

Drilling, cutting, and grinding of concrete generates concrete dust, containing crystalline silica, a substance known to the State of California to cause cancer, birth defects, or other reproductive harm. Avoid inhaling concrete dust by wearing a dust mask or other safeguards for personal protection. CA HEALTH AND SAFETY CODE 14808-60-7: Wear appropriate NIOSH designated dust mask to reduce risk of dust inhalation. Wear proper eye protection and avoid prolonged contact with eyes and skin. In the event of eye irritation, flush with water for 15 minutes and seek medical attention!

CAUTION: ASBESTOS

State and Federal agencies have determined that asbestos is a respiratory carcinogen. Avoid sanding or scraping of old vinyl, linoleum and VCT as they may contain asbestos. Take proper precautions and contact an asbestos abatement company to remove any old vinyl or vinyl tile floors containing asbestos. Cut-back adhesive and other types of adhesives can also contain asbestos.

Clean the Sub floor

After all prep work is completed, sweep and/or vacuum the sub floor. Dust and dirt can affect the adhesive or vapor barrier's ability to adhere to the slab.



Installing over Existing Floor Coverings on Concrete

Perimeter-glued resilient vinyl, VCT and rubber tiles are not acceptable underlayment's and must be removed.

Terrazzo, tile, and full spread glue-down vinyl's must be removed.

Existing hardwood flooring must be removed prior to the installation of a new wood floor on concrete.

Do not install over wood flooring glued to concrete.

Sub floor Moisture Testing WOOD

Probe-type (pin) meters are considered the best method of testing. Remember: the top and bottom of the sub floor should vary no more than 2%.

Wood substrates must have a moisture reading of no more than 12% when using Lignomat, Tramax, Delmhorst, or equivalent moisture meter, and be within 4% of the moisture content of the flooring to be installed

Sub floor Preparation WOOD

Wood sub floors need to be well nailed or secured with screws. Nails should be ring shanks, and screws must be counter-sunk. The wood sub floor needs to be structurally sound (i.e. without loose boards, vinyl, or tiles).

Sub floor tolerance for a flat surface is 3/16" within a 10' radius and 1/8" in a 6' radius. These are industry standards established by NWFA.

Engineered sub floor panels, must be ANSI-rated plywood, OSB (oriented strand board) of specified thickness to meet joist spacing specifications listed below, or sound solid lumber sub floor that is a minimum of 3/4" thick and dry.

1. For panel products sub flooring, check for loose panels and re-nail or screw down loose panels securely. Nails and screws must be countersunk.
2. Ensure that there is proper expansion space (1/8") between the panels. If panels are not tongue and groove and do not have sufficient expansion space, it may be necessary use a circular saw to create the specified space. Do not saw through joints on tongue and groove sub floors.
3. Check for delamination or damaged areas to sub floor and repair those areas as needed.
4. Make sure sub floor is free of debris before beginning installation.
5. Acceptable Panel Sub floors: Truss/joist spacing will determine the minimum acceptable thickness of the panel sub flooring.

Truss/Joist Spacing

- a. Truss/joist spacing of 16" (406cm) o/c or less, the industry standard for single panel sub flooring is a

minimum of 5/8" (19/32", 15.1mm) CD Exposure 1 plywood sub floor panels or 23/32" OSB Exposure 1 sub floor panels, 4' x 8' panels.

b. Truss/joist spacing of more than 16", up to 19.2" (488mm) o/c, the standard is a minimum 3/4" (23/32", 18.3mm) tongue and groove CD Exposure 1 Plywood 4' x 8' sheets glued and mechanically fastened.

c. Truss/joist spacing of more than 19.2" (488mm) o/c up to a maximum of 24" (610mm) requires a minimum 7/8" tongue and groove CD Exposure 1 plywood sub floor panels, 4' x 8' sheets, glued and mechanically fastened, or nominal 1" OSB Exposure 1 sub floor panels glued and mechanically fastened—or two layers of sub flooring.

NOTE: Subfloor deflection is the number one cause of squeaking in nail-down floors. If subfloor deflection exists corrective measures must be taken to correct it, even if the subfloor thickness meets industry specifications for thickness of subfloor in relation to joist spacing!

JOIST CROSS-BRACING / SOLID BRIDGING

A sub floor that is not thick enough to support the span of the joists will cause unacceptable sub floor deflection. An alternative to adding additional plywood on top of the sub floor would be to place a solid cross-brace between the joists. The cross-bracing would be done at the appropriate distance on center to meet specification and bring the deflection within proper tolerance.

Check with the joist or truss manufacturer to determine if cross-bracing is allowed with that system. Should it not be compatible with the joist or truss manufacturer, sheeting the sub floor with a second layer of CD or better grade plywood would then be the only option. (See double layer sub floors section).

DIRECTION OF INSTALLATION IN RELATION TO JOIST POSITION

The best application is at a 90° angle across the joists. This provides for best stability of the floor. As an alternative, the floor can be installed at a 45° angle to the joists. The floor cannot be installed in the same direction as the joists

without installing an additional sheet of plywood on top of the existing wood sub floor. Installing the same direction as the joists without reinforcing the subfloor is common cause of squeaking in a nail down floor.

When installing the flooring in the same direction of

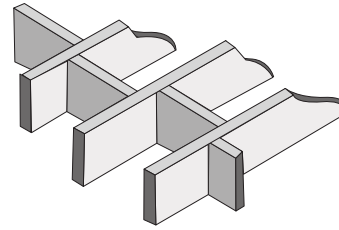

the joists, a second layer of plywood is required to stiffen sub floor. Subfloor must be sheeted with 1/2" (15/32", 14mm) CD exposure 1 plywood sub floor panels. Use same method as attaching to solid board sub flooring.

SHEETING EXISTING SUB FLOORS

SOLID BOARD SUB FLOORING

Solid Board Sub flooring should be 3/4" x 5 1/2" (1" x 6") group 1 dense softwoods (SYP, Doug Fir, Larch, etc.), #2 common, kiln-dried. Solid board sub flooring should consist of boards no wider than 6", installed on a 45° angle, with all board ends full bearing on the joists and fastened with a minimum 8d rosin-coated or ring-shanked nails, or equivalent. Solid board sub flooring that is uneven at the edges should be repaired and sheeted with 1/2" (15/32", 14mm) CD exposure 1 plywood sub floor panels, 4' x 8' sheets, and should be installed running cross-truss/joist. Glue top and bottom layer together with construction adhesive and screwing into the truss/ joist system every twelve inches.

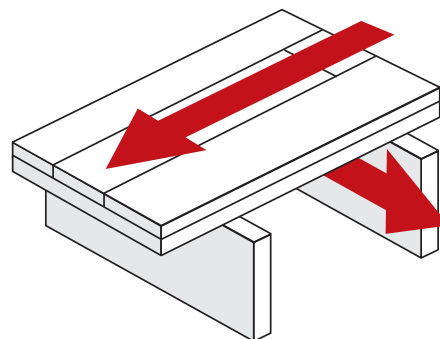

Additionally, nail (ring shank) or staple layers together on a minimum 12" grid pattern. Sheets should be glued to lumber subfloor using good quality

construction adhesive, and screwed to joists. Sheeting must be nailed or stapled to sheeting.

When sub floor **does not** meet thickness standards for span between joists, a second layer of plywood is required to stiffen sub floor. See item C of previous section

The minimum second layer should consist of nominal ½" (15/32", 11.9mm) CD exposure 1 plywood sub floor panels, 4' x 8' sheets, depending on how much correction of deflection between joists is necessary. A thicker layer may be required to offset joist spacing.

The top layer of plywood should be offset by 2' from joints in first layer of sub floor, and installed in the opposite direction to the bottom sub floor panels. Glue top and bottom layer together with construction adhesive (specified as suitable for this use) and screwing in to the truss/joist system every twelve inches. Additionally, nail (ring shank) or staple layers together on a minimum 12" grid pattern.

GENERAL INFORMATION: No fiberboard or particle board panels acceptable for nail down installation. Underlayment/industrial grade particle board sheeting over existing wooden sub floor is usually suitable for glue down applications. See adhesive manufacturer's specifications to ensure adhesive is suitable for use over underlayment/industrial particle board sheeting. Countersink all screws/ nails and sand any uneven edges smooth. High spots should be sanded smooth and low spots shimmed with plywood that is secured to the sub floor and sanded flat.

CEMENTITIOUS PATCH - WOOD SUB FLOOR
Do not use cement-based patch to correct any wooden sub floor problems in preparation for nail down. In the event of moisture, determine source, eliminate, and allow sub floor to dry. If sub-floor is less than above specified thickness, or sanded to thickness less than specified see the above standards for top sheeting.

EXISTING WOOD FLOOR - ON WOOD SUB FLOOR

When installing over an existing solid hardwood floor already attached to the wood sub floor, ensure that the existing floor is sound and firmly

attached to sub floor. Install material at a 90° right angle or 45° angle (across grain) of existing hardwood floor.

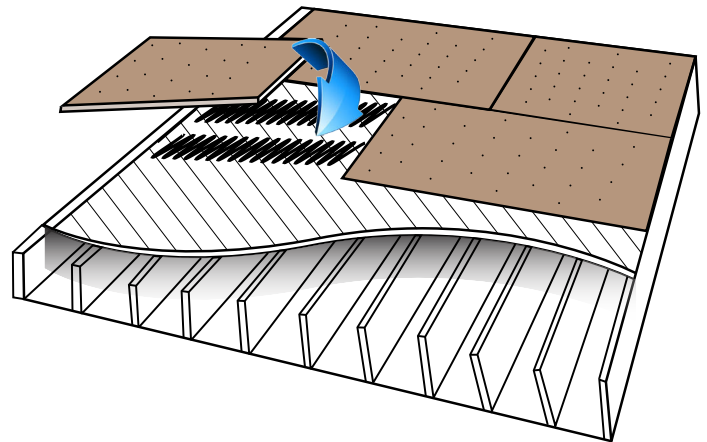

NOTE: Do not install in the same direction as existing floor.

Radiant Heat

Hallmark Solid Hardwood Floors are not suitable for use over Radiant Heat.

Below Grade Installation

A concrete slab is considered below grade when any part of the slab is below ground level. For example, a basement with a walk out is considered below grade. A house cut into a hill is also considered to be below grade if it isn't properly graded to create a drainage swale on the lot. **Solid hardwood flooring is not suitable for below grade installation.**

Getting Started

1. Select Installation Type

ABOVE GRADE WOOD SUB FLOOR: Glue, Nail, Glue Assist Nail.

ABOVE GRADE WOOD SUB FLOOR: Nail - Nail W/ Glue Assist

ON or ABOVE GRADE CONCRETE: Glue

WOOD SUB FLOOR WITH CRAWL SPACE: Nail - Nail W/ Glue Assist

NOTE: Hallmark Floors solid hardwood floors are not approved for above grade lightweight concrete or radiant heat. **Not Approved for below grade installation.**

2. Cabinets & Appliances

NAIL DOWN & GLUE DOWN: Cabinets and built in appliances (sub-zero refrigerators & dishwashers) should be installed prior to the installation of the hardwood floor. **Cabinets and built in appliances should not be installed on top of the floor.**

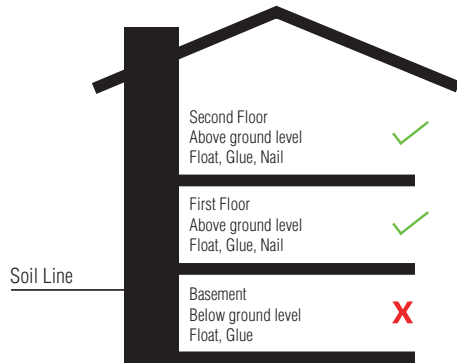

Installation of cabinets on top of nail-down and/or glue down floors can contribute to squeaking or objectionable noises in floor.

Installation of cabinets on top of glue or nail down installation does not invalidate warranty. However, since this is not best practice, should the floor require repair under warranty, Hallmark Floors will not be liable for costs to remove and replace cabinets and or counter tops to effect repair.

Hardwood flooring should be installed at the same time as carpet and after the following: finishing walls, cabinet installation, appliance installation, tile & counter top installation. Standard refrigerators and kitchen oven/range are acceptable for placement on top of the wood floor. Use caution when moving appliances by using a proper furniture dolly, air sled, 1/8" Masonite with glossy side down, or plastic glides designed for movement of heavy appliances. Failure to follow these precautions will damage the floor

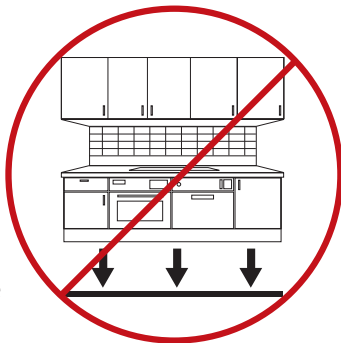

3. Undercut All Door Jambs/Moldings

Remove all shoe and base molding to ensure adequate expansion space. Use scrap piece of

flooring to establish height of cut. Make allowances for adhesive or underlayment thickness when establishing height of cut.

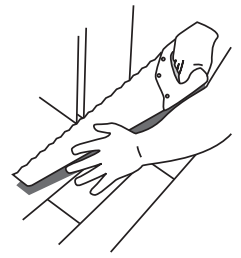

4. Visual Inspection of Boards

Visually inspect boards for any defects prior to installation. Verify that homeowner has seen product and approves/authorizes proceeding with installation of the floor, and prior to removing materials from boxes to acclimate.

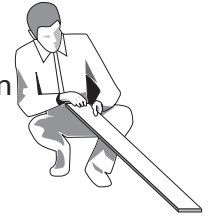

5. Work From Multiple Boxes

Always work from multiple boxes simultaneously and blend the boards throughout the installation. This is especially important with mixed production dates. Hallmark has very good color consistency, and mixed production dates are acceptable for installation. Working from multiple boxes/production dates helps achieve a good color blend.

6. Pre-Blend Boards to Moldings

Before you get started, open multiple boxes and check how the boards blend with the moldings. At beginning of installation, set aside those boards that best blend to the transition moldings on job.

7. Select a Starting Point

It is recommended to start the installation along an exterior wall. Check to make sure the wall is straight and square to the room. If floor installation starts in center of room establish a straight line.

8. Starting Line Expansion Space Side & Ends

Cut blocks to use against side and end walls to maintain 1/2" minimum expansion space. Use of adjustable spacers may be needed to help maintain a straight line.

9. Establishing End Joint Spacing

Applicable for all three methods of installation (glue-down, nail down, float). Each box contains random length boards. Use these boards as well as making some random cuts to establish a random pattern. Maintain a minimum distance/stagger between end joints of 6-8".

10. Change of Direction

GROOVE TO GROOVE, USING A SLIP TONGUE/ WOOD SPLINE:

Slip-tongue/wood-spline can be fabricated using birch plywood, cut into strips on a table saw. Cut

width to 5/16" wide to allow room for glue once inserted. The following thickness of Baltic Birch plywood should be used to fabricate wood spline for the following thickness of Hallmark Flooring:

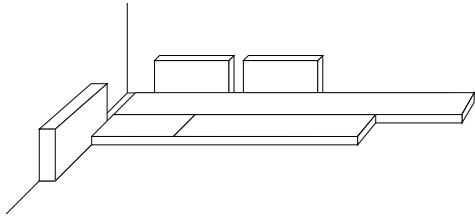

3/4" = 6mm or 1/4" birch plywood

Note: Sand corners of spline with sanding block and 60 grit sandpaper to soften/round the edges (all four sides).

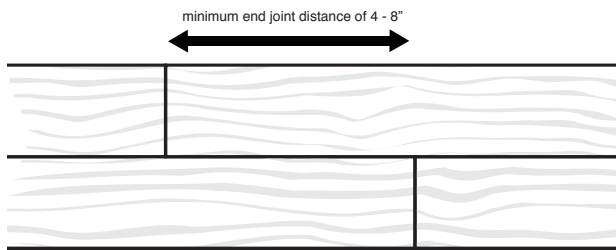

Installation Alert

Do not use rubber mallets or hammers on the finished edge of the floors. Do not kick the floor into place. Mallets or shoes should not be used to kick the floor in place. Hammers/mallets damage the finished edge and kicking can scratch the floor.

Glue Down Installation - Concrete Only

GENERAL INFORMATION

NOTE: Follow instructions 1-11 and all directions listed below.

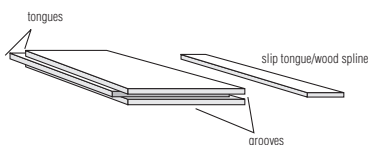

Installation Tools GLUE DOWN

Tape measure, pencil, chalk line, table saw, cut-off saw, jamb saw, tapping block, pull bar, spacers, ratcheting floor straps, hammer, safety glasses, hearing protection, utility knife, specified notched trowel, wall spacers, straight edge,

broom, speedy square, hardwood floor cleaner, and shop vacuum.

Glue Down Installation Concrete Only

12 GD. Remove Tongue & Lead with Groove

Cut off tongue on very first row to be installed and lead with the groove. This enables the tongue to be partially inserted into the groove before coming into contact with the adhesive

13 GD. Starter Rows

Measure the equivalent of four to five rows, mark sub floor at both ends of run and snap a chalk line. Spread adhesive to chalk line. Repeat this process on all subsequent rows of material throughout the balance of installation.

NOTE: It may be necessary to use painter's tape for delicate surfaces during the install to keep planks together, while glue dries. Remove delicate surface painter's tape within 24 hours of application.

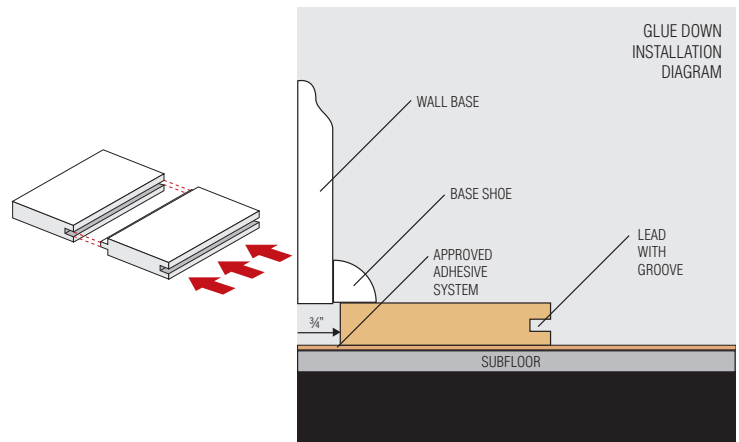

14 GD. Strap Starter Rows

Once starter rows are installed up to chalk line/edge of adhesive bed, strap across the grain. Allow adhesive to set up long enough to have a firm hold. Use the flat side of the trowel to flatten any adhesive at edge of the leading board. Once the boards are firmly seated, proceed to work across the floor. CAUTION: Do not let boards open or drift off straight line.

15 GD. Check Straight Lines

Run string along joint lines to check in you are wandering off line and use caution to keep all end and

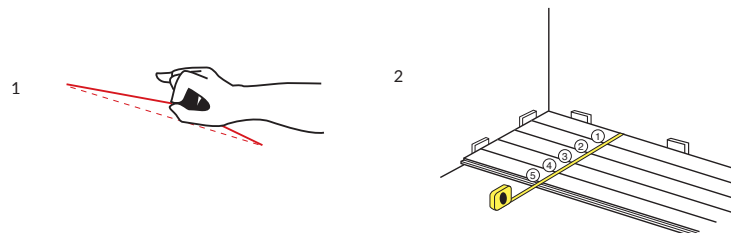

side joints closed. The edge of a 6' level or straight edge along the leading rows can also help determine the maintenance of a straight line.

16 GD. Trim Last Row

Cut the last row and snug into place using a pull tool. Face nail with 18-gauge nails at edge of last row.

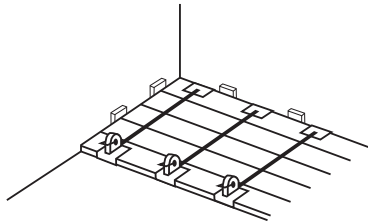

17 GD. Install Transition Moldings

Install moldings using urethane glue or high-quality adhesive. It may be necessary to place weight on edge to ensure molding level is flush with flooring.

Nail Down Installation – Wood Subfloor

GENERAL INFORMATION

NOTE: Follow instructions 1-11 and all

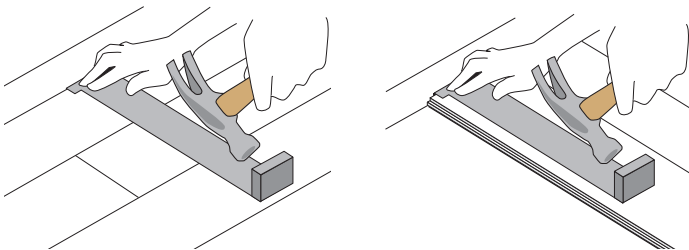

directions listed below.

Installation Tools NAIL DOWN Tape measure, pencil, chalk line, table saw, cut-off saw, jamb saw, tapping block, pull bar, spacers, hammer, safety glasses, hearing protection, utility knife, wall spacers, straight edge, broom, speedy square, hardwood floor cleaner, pin/finish nails, air compressor, and shop vacuum.

GENERAL INFORMATION NOTE: Follow previously listed instructions 1-11 and all directions listed below.

Proper placement of fasteners, proper size, and coating of staples is critical to the performance of the floor. Overshooting the fastener weakens

the tongue and the damage can telegraph to the surface. Care must be taken not to damage the edge of the plank with mallets or the edge of the nail gun. Improper placement will create a noisy floor.

Air Pressure Settings

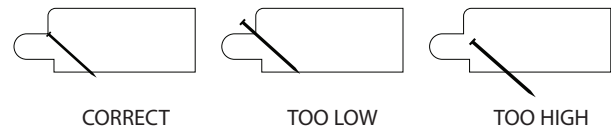

Approved Nail/Staple Systems

- ✓ POWER NAIL AIR DRIVEN MODEL 445FS
15 ½ gauge x 2" Coated Staple
- ✓ POWER NAIL AIR DRIVEN 445 OR 445FLEX POWER ROLLER
16 gauge x 2" Cleat
- ✓ PORTA-NAI LS AIR DRIVEN MODEL 470A
16 gauge x 2" Cleat (L-Nail)
- ✓ PORTAMATIC HAMMERHEAD TL
16 gauge x 2" Coated Staple
- ✓ PRIMATECH AIR DRIVEN MODEL 250ALG GYM
16 gauge 2" Cleat
- ✓ STANLEY BOSTITCH AIR DRIVEN MIIIFS -HARDWOOD FLOORING STAPLER
15.5 gauge x 2" Coated Staple

Fastener Spacing next page 14ND

NOTE: REGARDING NOISY FLOORS.

Squeaking/noisy floors are invariably related to movement. The movement is commonly associated with deflection of the subfloor. Many times too much deflection exists in the subfloor between the joists. Sag between the joists is another common cause of objectionable noises from the floor.

Incorrect placement of a fastener (improper nail-gun shoe adjustment, incorrect air pressure), incorrect spacing, incorrect size of fastener (too short, too long, uncoated staples, too heavy a gauge) are very often the cause of noise.

Lack of expansion space, installing cabinets and built ins on top of the floor, and incorrect acclimation

(swell of planks), poor quality subfloor (OSB or Plywood that has gotten excessively wet during construction) lose strength and may be unable to properly hold a fastener, as well as, lack of proper underlayment, all cause movement related noise.

Hallmark Floors adheres to all NWWA/NOFMA standards for milling tolerances at time of manufacturing. Excessive swelling or shrinking related to adverse environment can effect milling tolerance.

Objectionable noise is not related to a manufacturing defect and expressly excluded from warranty.

NOTE: Any defects in milling must be determined in the first 10% or 100 sq. ft. (which ever is less) of the floor being installed. If milling is to industry specifications and instead is related to installation or site related issues the material will not be eligible for replacement.

12 ND. Underlayment

RECOMMENDED UNDERLAYMENTS

15 to 30 lb. roofing felt when doing a nail-down installation. Staple in place and then proceed to install the floor.

Aquabar "B" Hardwood Floor & Tile Underlayment. Staple in place and then proceed to install the floor.

Allglobe -Silicone Vapor Shield. Staple in place and then proceed to install the floor.

CAUTION: Red Rosin or craft paper is not an accepted underlayment. Foam underlayment pads are not acceptable for

nail down. Elimination of underlayment's in favor of running beads of construction adhesive to increase the holding power to the sub floor has some risks. Underlayment's have always acted as a vapor inhibitor. Without the underlayment, the floor is subject to cupping and crowning from moisture intrusion from the sub floor

13 ND. Starter Rows:

Nail-down method requires that installation be done by leading with the tongue. When starting at the wall, trim groove off the back of the boards

being used for the starting row. Face nail the back edge of the board with 18-gauge nails, then blind nail into the pocket above the tongue with one of the above approved nail/ staple systems. As face nailing is accepted practice, face nailing the boards as far back as possible can help hide the face nailing under the base and quarter round/base shoe. It may be necessary to blind nail the tongues of the starter boards to eliminate any surface nail holes until far enough from the wall to use floor nailer

14 ND. Nail/Staple Spacing

Nail/staple spacing needs to be 4" to 6" apart and within 2" of board ends. Installer should be standing directly on top of the board being nailed down. This ensures the bottom of the plank is firmly seated on the sub floor. Check regularly to ensure the plank is snug to the sub floor. Any gap between the bottom of the plank and the sub floor is a source for squeaking. Warning: Nailing too close to end could fracture the corner of the plank.

15 ND. Check Straight Line

After three rows of flooring have been installed, take a six-foot level and check the leading edge to be sure floor is on a straight line. Lay the level on its back and glide bottom edge along the tongue. Failure to stay on a straight line will cause irregular gaps in floor on sides and ends.

16 ND. Trim & Face Nail End Rows

Cut the last row and snug into place using a pull tool. Face nail the remaining rows with 18 gauge nails. It will be necessary to face nail the remaining rows

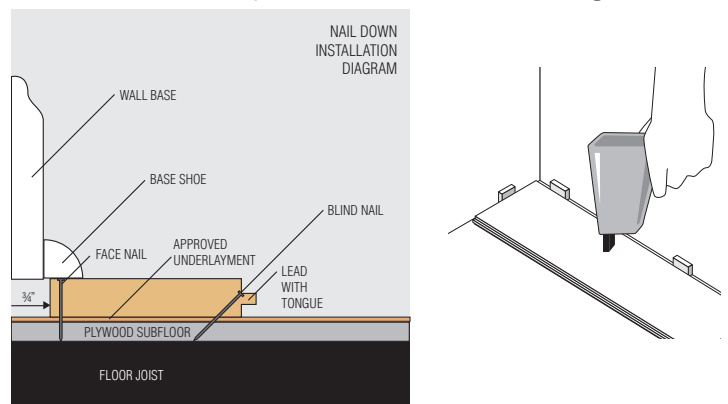

when the blind nail gun is too close to the wall to fasten down the planks.

Special Instructions Glue Assist Nail Down

GENERAL INFORMATION NOTE:

The following is an addendum to the nail down section. A great deal of controversy surrounds the practice of glue assist/nail down. The underlying risk in this method is that the vapor barrier sheet is now missing from the surface of the subfloor.

The vapor barrier sheet can act as a safeguard against seasonal changes in humidity in a basement or crawlspace, and not using a vapor barrier sheet carries additional risk that will require more diligence by the homeowner. Stringent control of humidity/ moisture in basements, and crawl spaces must therefore be exercised.

A moisture imbalance in the bottom of the plank, due to a lack of moisture control, combined with drier air in the room above can cause moisture related damage to the floor.

Hallmark Floors, like the entire wood flooring industry, has no warranty against moisture related issues with the floor.

1 ND/GA. Subfloor Deflection

The primary cause of squeaking floors is related to subfloor deflection/subfloor movement, between the joists. Even if the subfloor is the proper thickness to meet specifications, this can still be an issue due to the subfloor not having enough tensile strength to perform to industry specifications.

2ND/GA. Felt or paper barrier

Barriers of any kind cannot be used for this application method. Glue assist cannot be applied to the surface of a moisture membrane such as Aquabar or 15lb roofing felt. Unfinished basements or uncontrolled crawl spaces may expose the subfloor and the plank itself to elevated moisture contents that will cause excessive expansion of the floor. Finished basements and enclosed crawl spaces with proper humidity control are required for glue assist.

3ND/GA. Subfloor Moisture - CAUTION

Moisture intrusion or exposure to moisture is not covered under warranty.

4ND/GA. Glue Type & Application Method

Glue must be a high quality urethane construction adhesive. The glue should be applied in a serpentine pattern on the bottom of the plank, as shown in diagram to right.

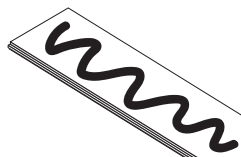

NOTE: Glue assist applications will not perform properly when applied to the surface of a vapor barrier such as Aquabar or 15lb roofing felt. Glue assist will only work on the wood subfloor itself without a vapor barrier applied.

Clean Up

A. Clean up any adhesive or glue residue immediately. If glue or adhesive is allowed to dry on the floor's surface, it can damage the finish when it is removed.

B. Completely remove any delicate surfaces painter's tape (never use masking tape) within 24 hours of application. If direct sunlight is hitting tape, it must be removed within 12 hours.

C. Adhesive residue, glue residue, and shoe marks can be removed with mineral spirits. Nu Oil®: Follow immediately with Nu Oil® Natural Oil Cleaner to remove any mineral spirit residue. TrueMark Poly/Glaze Tek® Finish: Follow immediately with TrueClean® Floor Cleaner to remove mineral spirit residue.

D. Remove dust and dirt regularly during installation and upon completion with a soft brush attachment on a shop vacuum.

E. Move refrigerators with a soft wheel dolly or glides to avoid denting floor. Do not install stiff copper tubing from water source to ice maker. Use flexible braid tubing instead. A braided hose is much more durable and less prone to leak. For flooring touch up and scratch repair, refer to Hallmark Floors Total Floor Care Hardwood Floor Touch Up Guide. Maintenance & Warranty Guide for Nu Oil® Finish <https://hallmarkfloors.com/pdfs/MaintenanceWarrantyNuOilWEB.pdf>



Hallmark Floors
Solid Hardwood Installation Instructions
V.5.2020